



1 valentine's buildings

Bechers drive

Aintree racecourse Business Park

L9 5ay

CF1 L GAS APPLIANCE

THE CONNELLY COLLECTON

INSET CONVENTIONAL FLUED GAS FIRE

INSTALLATION & USERS INSTRUCTIONS

FOR USE WITH NATURAL GAS

G20 @ 20 mbar

For use in GB and IE



THESE INSTRUCTIONS MUST BE LEFT WITH THE USER FOR FUTURE REFERENCE

These instructions cover the models listed below as part of the cf1L range

The Connelly Collection

1. Standard convector box
2. Tall convector box
3. Small convector box
4. Wide convector box

CONTENTS

SECTION	INFORMATION & REQUIREMENTS	PAGE
1.0	IMPORTANT NOTES	3
2.0	INSTALLATION REQUIREMENTS	4
3.0	APPLIANCE INFORMATION	5
4.0	FLUES AND BUILDERS OPENING REQUIREMENTS	7
5.0	FIREPLACE OPENING SIZES AND CATCHMENT SPACE	8
6.0	INSTALLING THE CONVECTOR BOX	9
7.0	CONNECTING THE GAS AND TESTING	11
8.0	INSTALLING THE FUEL PIECES	11
9.0	LIGHTING THE APPLIANCE (USERS INSTRUCTIONS)	16
10.0	INSTRUCT THE USER	29
11.0	MAINTENANCE	29
12.0	SERVICING	31

1:1

This fire should be installed and serviced **every 12 months** in accordance with current gas safety (Installation and uses) regulations by a competent person who is a member of a recognized gas installer's Organization (e.g. Gas safe) and in accordance with the installation instructions.

1:2

The flue should be inspected before your appliance is installed and checked annually to ensure continuous Clearance of combustion products and safe operation.

The chimney must be swept before installation.

1:3

UNDER NO CIRCUMSTANCES must the fire be used if the glass door panel is broken cracked or Damaged

1:4

IMPORTANT.

The glass panel door and other outer parts, (e.g. outer frame and door) will become hot in use; clothes Etc. should not be wrapped over or near the fire and we recommend that a 'fire guard conforming to BS 8423 should be used for the protection of young children the elderly the infirm and pets'.

1:5

DO NOT burns paper or rubbish in the fire.

1:6

It is important for the safe operation and to maintain efficiency that the fire is not operated with damaged or Broken fuel effect pieces or ceramics.

UNDER NO CIRCUMSTANCES should extra fuel effect pieces be used.

1:7

When the fire is first used it may emit a slight odor or smoke, this is due to the newness and will Disappear. **DO NOT WASH OR VACUUM** the Fuel Effect ceramic pieces.

1:8

The fire **MUST** be installed into a Builders Opening in line with the Installation Instructions.

No combustible material should be placed within 150mm of the appliance

Any combustible material above the opening should be removed up to a height of

500mm. any shelf above the fire should not project more than 150mm forward.

For deeper shelves allow a 15mm increase in height for every 25mm in depth.

1:9

These instructions are intended to assist you in the correct operation of your appliance and Should be kept safe for future reference

2: INSTALLATION REQUIREMENTS

2:1

In your own interest and that of safety, it is law, that a competent person who is a member of a recognized gas installation organization must install all gas appliances (E.g. Gas safe) In accordance with Current Gas Safety (INSTALLATION AND USE) Regulations.

2:2

Before installation, ensure that the local distribution conditions (identification of the gas and pressure) and the adjustment of the appliance are compatible.

The installation must be in accordance with these installation instructions and all relevant parts of the Local and National Building Regulations, the Building Standards (Scotland) Regulations and the relevant recommendations of current editions of the following British Standards: -

BS	BS	BS	BS	BS
5871	8303	5440 PART 1	5440 PART 2	6891

2:3

IMPORTANT: This appliance is fitted with a spillage monitoring system, (ODS) and must not be adjusted, bypassed or

Put out of operation, by the user or installer. Any parts of this system should only be exchanged for genuine crystal

Manufacture parts.

This fire must not be installed in a room that contains a bath or shower.

This fire cannot be installed onto a combustible wall. All combustible materials must be removed from the area shown in section 11-appliance location

2:4

No combustible materials must be present in the builders opening.

These Instructions must be left with the User.

2:5

VENTILATION: GB

For installation in Great Britain additional ventilation is not normally required unless indicated as being required by the 'Spillage Test'

2:6

VENTILATION: IE

For installation in Southern Ireland ventilation must be in accordance with I.S813 Domestic Gas Installations.

2:7

FLUE AND CHIMNEY SUITABILITY

This appliance is designed for use with conventional brick built or lined chimneys and fabricated flues and metal flue boxes conforming to BS715 / BS EN 1856-2 .all flues must conform to the following minimum dimensions

2:8

Minimum diameter circular flues 125 mm

Minimum effective height of all class 1 (175mm) flues 3 metres

Minimum effective height of all class 2 (125mm) flues 4 metres

2:9

ENSURE THAT IF INSTALLING THIS PRODUCT INTO A BRICK BUILT CHIMNEY, THE CHIMNEY HAS BEEN FULLY SWEEPED PRIOR TO PROCEEDING WITH THE INSTALLATION

3: APPLIANCE INFORMATION

MODEL	STANDARD	TALL	WIDE	SMALL
GAS TYPE	G20	G20	G20	G20
INJECTOR	500	500	500	500
MAX GROSS INPUT	5.5kW	5.5kW	6.3kW	5.5kW
MIN GROSS INPUT	2.9kW	2.9kW	4.1kW	2.9kW
COLD PRESSURE	20 +/-1mbar	20 +/-1mbar	20 +/-1mbar	20 +/-1mbar
IGNITION	AUTOMATIC	AUTOMATIC	AUTOMATIC	AUTOMATIC
SPARK GAP	4mm	4mm	4mm	4mm
PACKED WEIGHT	KG	KG	KG	KG
GAS CONNECTION	8mm	8mm	8mm	8mm

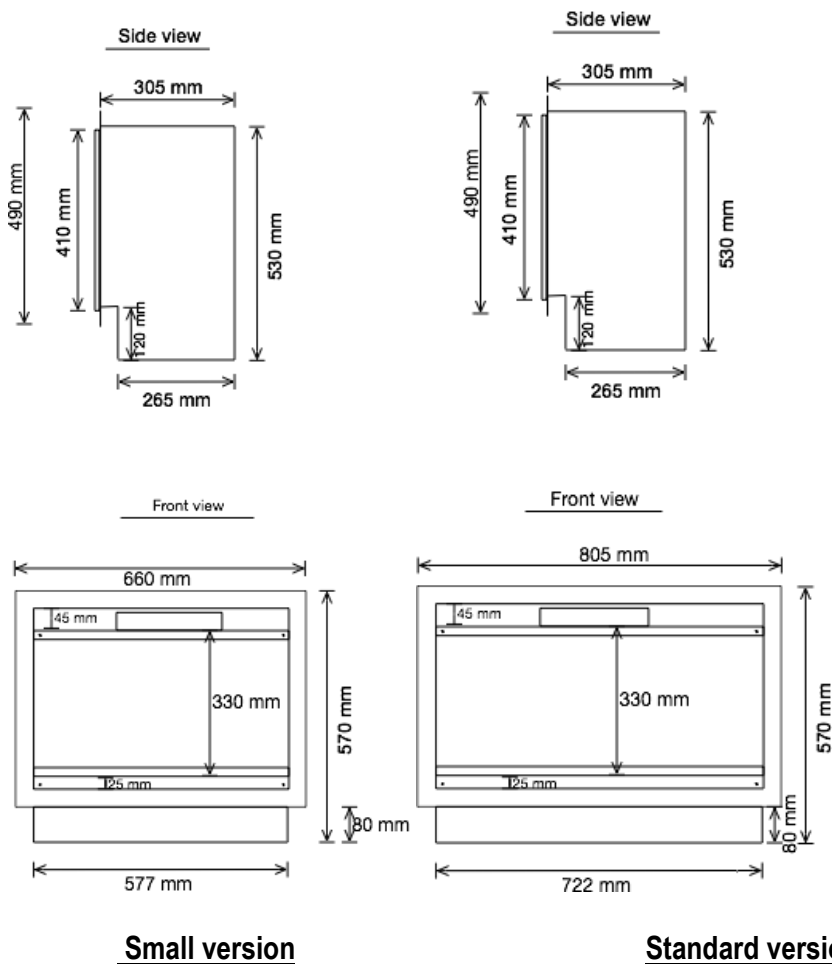

ALL MODELS HAVE A 25mm AIR SUPPLY AT THE FRONT BOTTOM UNDER NO CIRCUMSTANCES SHOULD THIS BE BLOCKED OFF AT ANY TIME

Side view

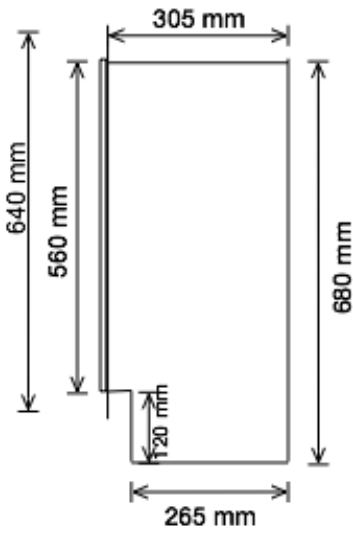

Side view

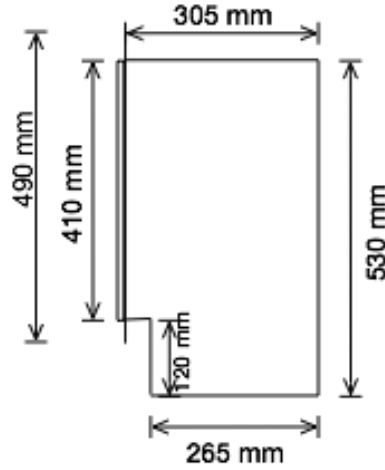

Front view

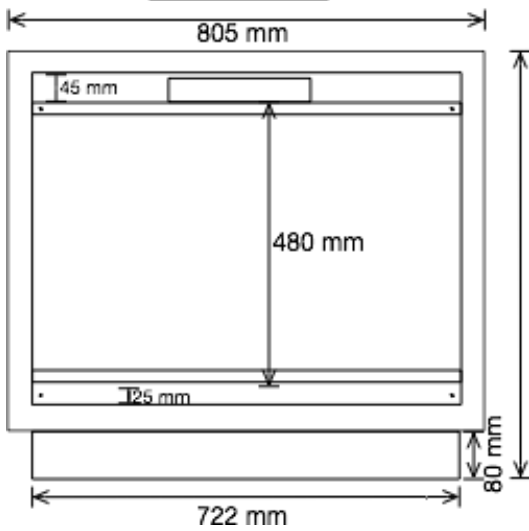

Front view

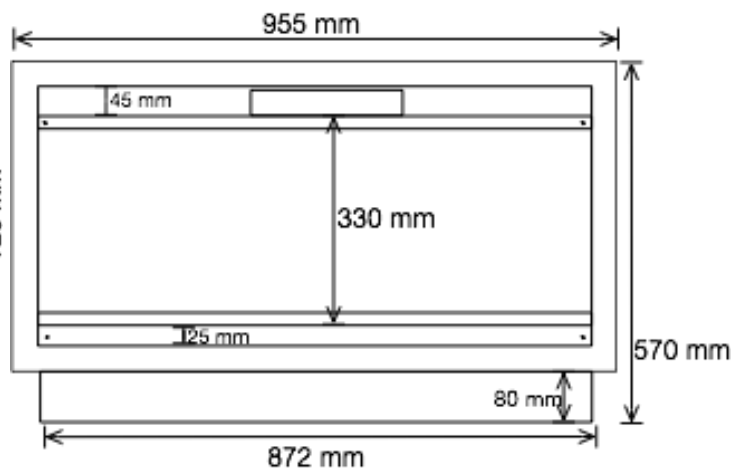

Tall version

Wide version

ALL MODELS HAVE A 25mm AIR SUPPLY AT THE FRONT BOTTOM UNDER NO CIRCUMSTANCES SHOULD THIS BE BLOCKED OFF AT ANY TIME

4.1

Prior to creating the builders opening the flue must be checked.

No restrictor plate or flue damper is permitted.

The flue must be swept prior to installation.

The flue must be free of any obstructions.

The flue must be checked to ensure it **only** serves the fireplace opening to be used for the fire.

The flue must have a positive up-draught and checked as follows before the builders-opening is constructed

Any under floor air supply to the fireplace must be completely sealed off

Before installing the fire a simple smoke test should be carried out on the flue to check its condition. Light a smoke Generator, hold it at the top of the fireplace opening and observe that the smoke is being drawn up the flue, if so, proceed with installation. If not, pre heat the Flues for a few minutes and recheck, if smoke still fails to be drawn up the flue, further Investigation is required and the appliance **MUST NOT BE FITTED**.

Minimum diameter circular flues 125 mm

Minimum effective height of all class 1 (175mm) flues 3 metres

Minimum effective height of all class 2 (125mm) flues 4 metres

WARNING PASSING A SMOKE TEST IS NOT AN INDICATION THE APPLIANCE HAS PASSED A SPILLAGE TEST

BOTH TESTS ARE A SEPARATE PROCEDURE

4:2

Purpose Made Builders Opening With a Conventional Stone Flue.

With a minimum cross sectional dimension of 175mm (7") and minimum effective height of 3 metres.

The base of the builders opening must be a non-combustible material and at least 12mm thick. The Builders Opening must be at least 300mm off the floor for a wall mounted fire installation.

It is recommended that a qualified builder construct the builder's enclosure.

A lintel should be used to support the chimney breast above the Builders opening.

Any gaps around the Builders Opening, as may be the case with a dry liner wall must be sealed.

4:3

Additional Requirements for a Purpose Made Builders Opening with a Flexible Flue Liner or A 125mm (5") diameter flexible gas flue liner with effective height of 4 metres

Conforming to B.S 715, and connected to a Register Plate fitted and sealed above the Builders Opening.

4:4

A solid flue pipe 125mm(5") diameter and metal flue box conforming to B S 715 with effective height of 4 metres

4:5

SHELF POSITION

If the fire is to be installed into a suitable fire surround it must have a fire rating of 150C.

If the fire surrounds has a combustible shelf it must be at least 200mm above the top of the fire

And protrude from the wall be no more than 150mm

For every 25mm increase in depth of combustible Shelf the position of the shelf must be raised by a further 15mm.

5:1

Fireplace opening sizes and catchment space

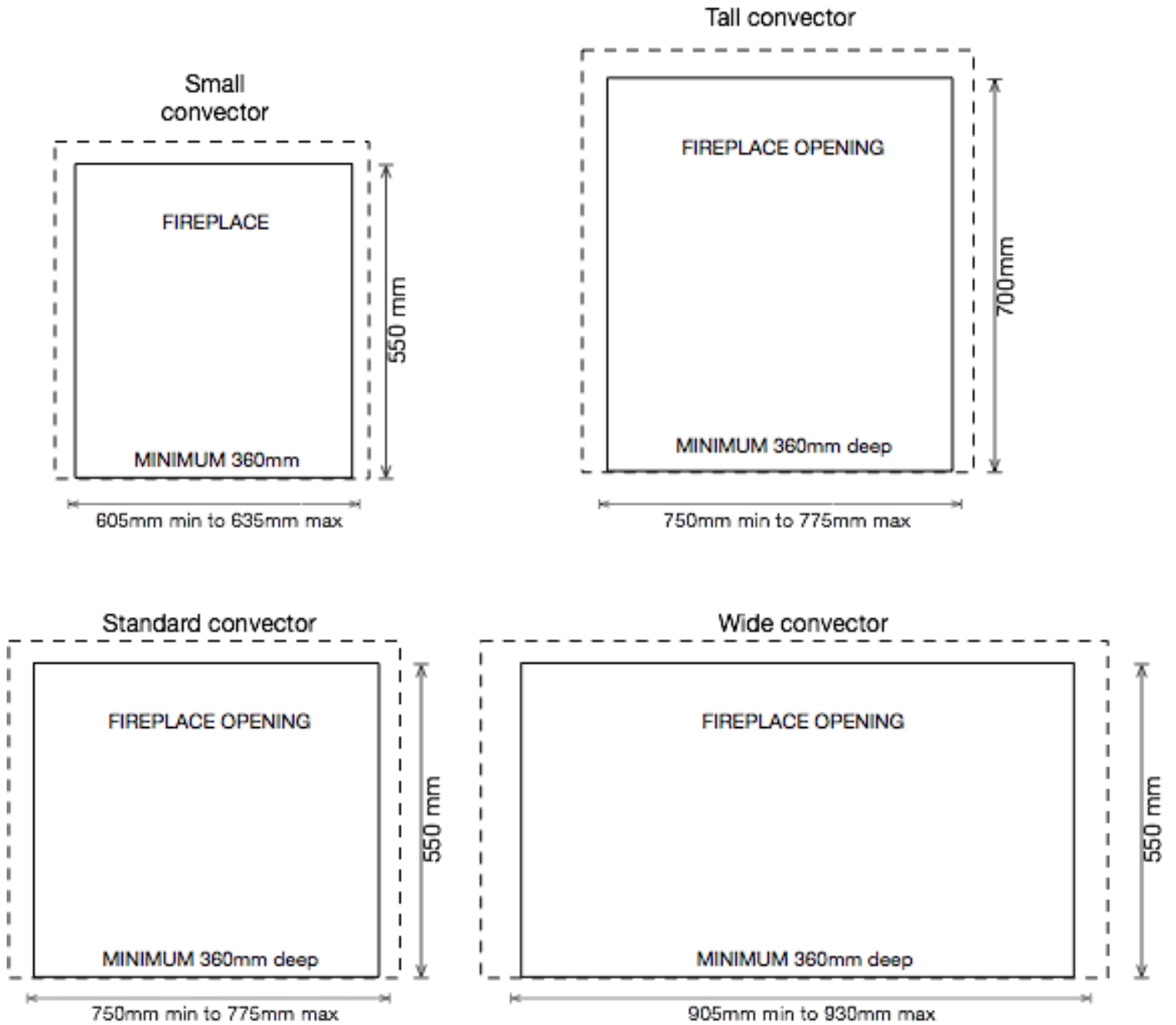

5:2

When installed into a brick built chimney, you must ensure that there is sufficient depth to accommodate any debris, which may fall from the chimney, this depth must be sufficient to accommodate 12 litres of volumetric space in a conventional brick built chimney

5:3

This appliance is not suitable for use in fireplaces fitted with an existing chairbrick , the chairbrick must be removed

INSTALLING THE CONVECTOR BOX

6:1

Establish which appliance you have and mark position in the wall for installation following the current rules in force, and form an opening to the sizes stated in section 5,

As these appliance are designed to be flush finished either up to a surround, marble or granite slips, or just heat resistant plaster finish the opening will allow the appliance to fitted into the underneath of the appliance will then have to be finished with the appliance in place, see diagram below

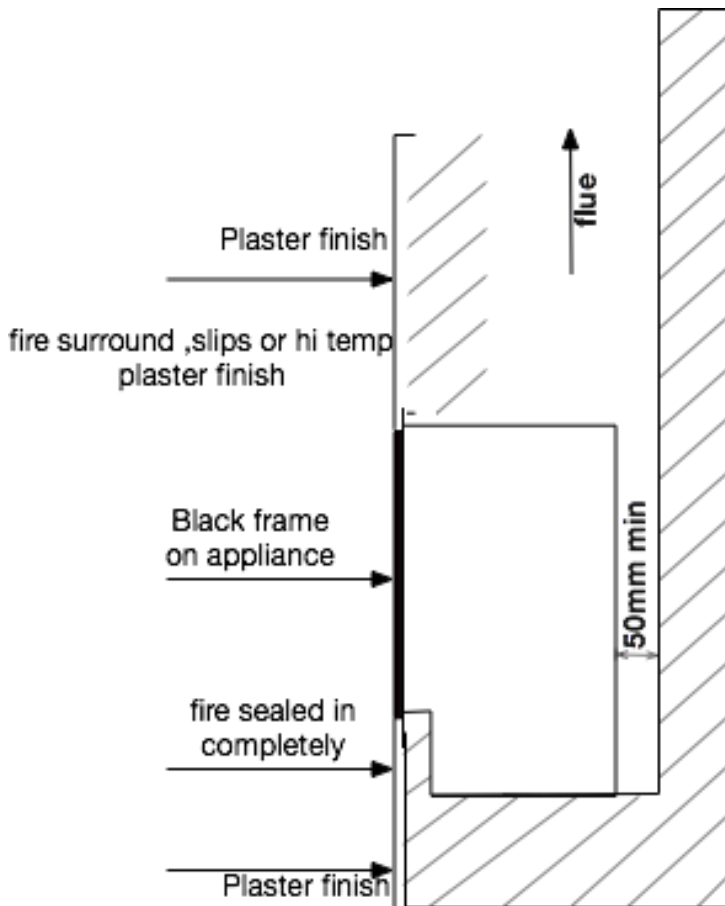

6:2

It is important when installing the convector box that all gaps around the inside of the fireplace opening are sealed .the base both sides left and right and the rear may even need pointing in between the brickwork it is important that the flue can only pull through the flue tunnel for the appliance to clear its products and work correctly

A spillage test will deem this to be correct if a spillage test fails it will be due to the appliance not being sealed in correct

6:3

With the opening being made correct the appliance can be removed from its packaging and the glass panel removed by unscrewing the 4 self tapping screws one in each corner and the glass frame can be removed

Pulling out at the 2 bottom corners and pulling the glass panel down can remove the glass panel

Once the glass panel is removed 6 screws hold the burner plate on, these can be removed and remove the plate

The gas burner is now held in by 3 screws remove these and lifts out the burner by lifting the right hand side and pull away to the right

Disconnect the off switch panel connector by pulling apart

Remove the 4 screws holding the fire tray in position and remove the fire tray

The gas pipe entry plate can be opened and the gas pipe installed ready for the box to be positioned

Position the box ensuring the gas pipe is bent into the box **(soldered joints are not accepted inside the box)**

With the box in position close the gas pipe entry plate and secure closed with the 2 screws

Below shows burner plate removed, remove the 3 screws shown to remove burner

6:4



6:5 Below showing Gas entry plate and debris inspection panel with the burner and burner plate removed

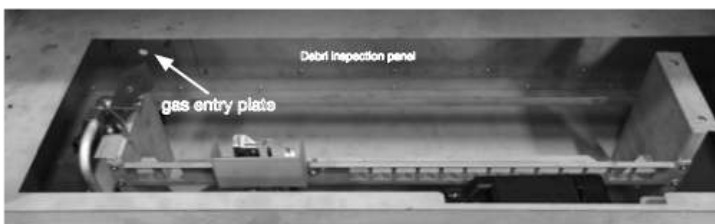

CONNECTING THE GAS AND TESTING

7.0

With the box installed and sealed in the gas pipe can be positioned, once positioned refit the fire tray connecting the off wire switch with the push on connector

Screw the fire tray down using the 4 self tapping screws and connect the gas pipe

Once connected Turn on the main gas supply and carry out a gas tightness test.

PLEASE NOTE - THE WORKING PRESSURE TEST ON THIS PRODUCT NEEDS TO BE COMPLETED BEFORE THE FUEL-BED IS FITTED.

Connect a manometer to the pressure test point and refit the burner ,fill the burner with the mica fil and turn on the appliance to the full on position and check the gas pressure is 20 mbars +/- 1 mbar

Once 20 mbars is verified remove the manometer and replace the test screw

the burner plate can now be replaced and screwed in position using the 6 self tapping screws

8:0Install the fuel following the following instructions

The connelly collection alternative fuel options

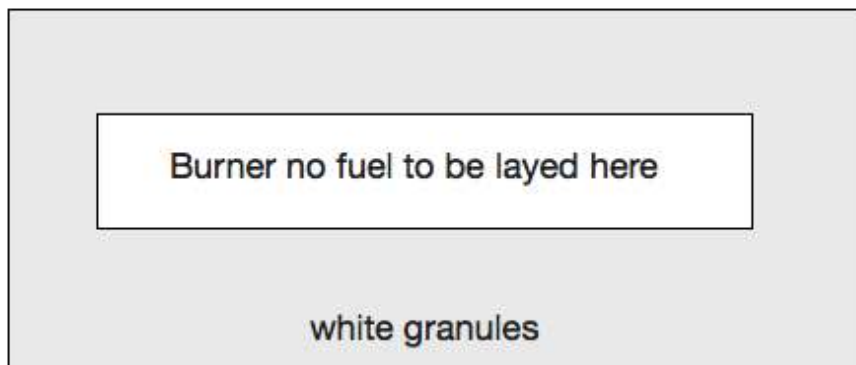

Alternative fuel options are available for these models and can be installed around the gas burner where the white granules are lay ,under no circumstances must the fuel be put across or in the burner .

This method only allows the fuel pieces to be decoration around the burner

also no fuel at all can be used to give a more minimal look
These fuel options come with a crystal fires instructions

fuel options available are pebbles or coals around the burner

LOG LAYOUT STANDARD & TALL

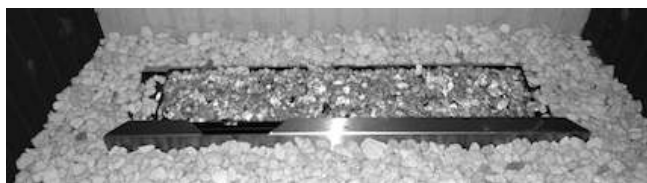

FILL THE BURNER WITH MICA FILL

THE BURNER IS SURROUNDED BY THE CHIPPING'S EVENLY SPREAD



THREE REAR LOGS SIT AS LEFT



TWO FRONT LOGS SIT AS LEFT



TOP LEFT LOG SITS ACROSS BUT DOES NOT IMPINGE THE FLAMES WHEN APPLIANCE IS TURNED ON

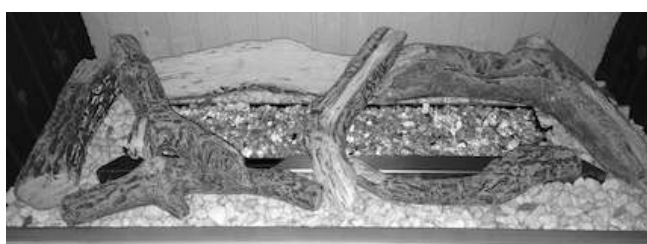

CENTRE LOG SITS ON REAR AND FRONT LOG



RIGHT LOG SITS ACROSS FROM REAR TO FRONT BETWEEN THE FLAMES

LOG LAYOUT WIDE VERSION



FILL THE BURNER WITH MICA FILL

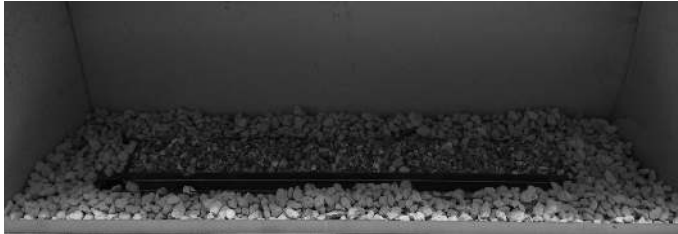

THE BURNER IS SURROUNDED BY THE CHIPPING'S EVENLY SPREAD



THREE REAR LOGS SIT AS LEFT



THREE FRONT LOGS SIT AS LEFT



FINAL 5 LOGS SIT ACROSS RAISED OFF BURNER THEY ARE POSITIONED THROUGH THE FLAME GAPS NOT IN THE FLAMES

Log layout Small



fill the burner tray with the brown mica fil.
around the burner tray the granules sit evenly
spread



The 2 rear logs sit as shown

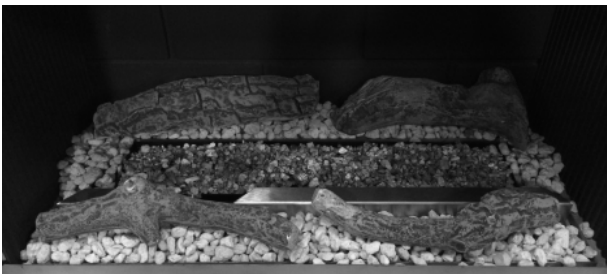

The 2 front logs sit as shown



The 3 logs sit across the burner as shown

8.1

After installing the fuel pieces the glass panel can be refitted by lifting the panel upwards into the channel and pushing the bottom onto the support

The glass doorframe can now be refitted using the four screws

The fire can now be turned on and a spillage test performed

check for spillage



Close all doors and windows.
with the fire operating at high for 5 minutes
Insert a smoke match into the grill 25mm in central
to the flue outlets as shown above
All smoke should be drawn into the Diverter, if not
wait a further 10minutes and repeat the test.
If there are any Extraction Fans in the room or
adjoining rooms set them at maximum and with
the door to this room open repeat the above
test. If spillage still occurs Seek Expert
Advise.,

If spillage persists, the flue is not functioning correctly and a fault exists. If after investigation the fault cannot be traced and rectified, the fire must be disconnected from the gas supply and expert advice obtained.

IMPORTANT: IF THE BURNER IS EXTINGUISHED FOR ANY REASON YOU MUST ENSURE THAT YOU WAIT A FULL FIVE MINUTES BEFORE ATTEMPTING TO RE-LIGHT THE FIRE.

9:1

Fire Control

This control is situated on your fire. The drawing shows the main features of the control.

The control required 3 AA size alkaline batteries to be inserted under the battery compartment cover. The orientation of these is shown molded into the battery compartment.

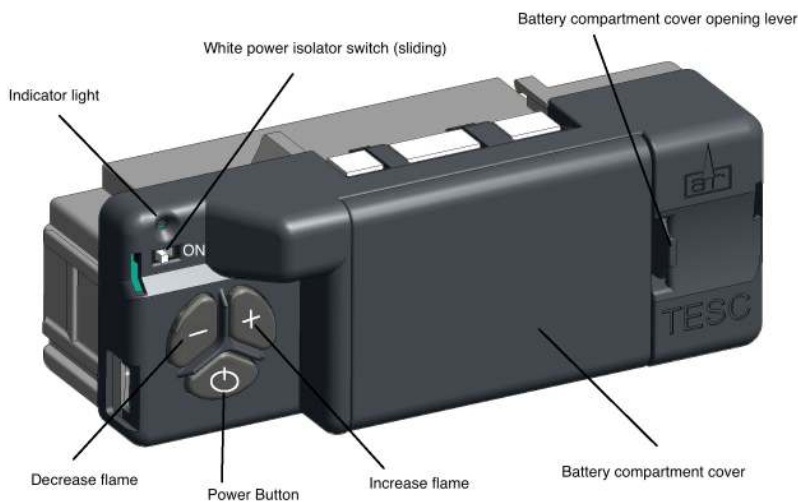

After fitting the batteries and replacing the cover the fire can now operate. Slide the slide switch to the right to the On position (I symbol).

To start the fire, press the power button and hold for 1 second then release. The burner will within around 1 to 10 seconds, adjust to the maximum power setting,

The power of the burner can be adjusted up and down by pressing the – and + buttons.

To stop the fire, simply press the power button again and the burner will stop.

If you are not intending to use the fire for a long period (i.e. over summer time months), the battery life can be extended even more by sliding the white isolator switch to the left(away from the On position, **symbol 0**)

Handset (if supplied)

Ensure the power isolator switch on the front corner of Fire Control is in the on position I. **NOTE:** For safety reasons a button must be pressed and released for the command to be recognized. Keeping hold of a button when pressing (unless other wise instructed) will not be recognized as a command press.

Grasp around the handset to unlock its functions. The green unlock light will illuminate to show when the handset is unlocked and ready to accept commands. (N.B. Keep a grip of handset to keep it unlocked, to continue to operate the command buttons.)

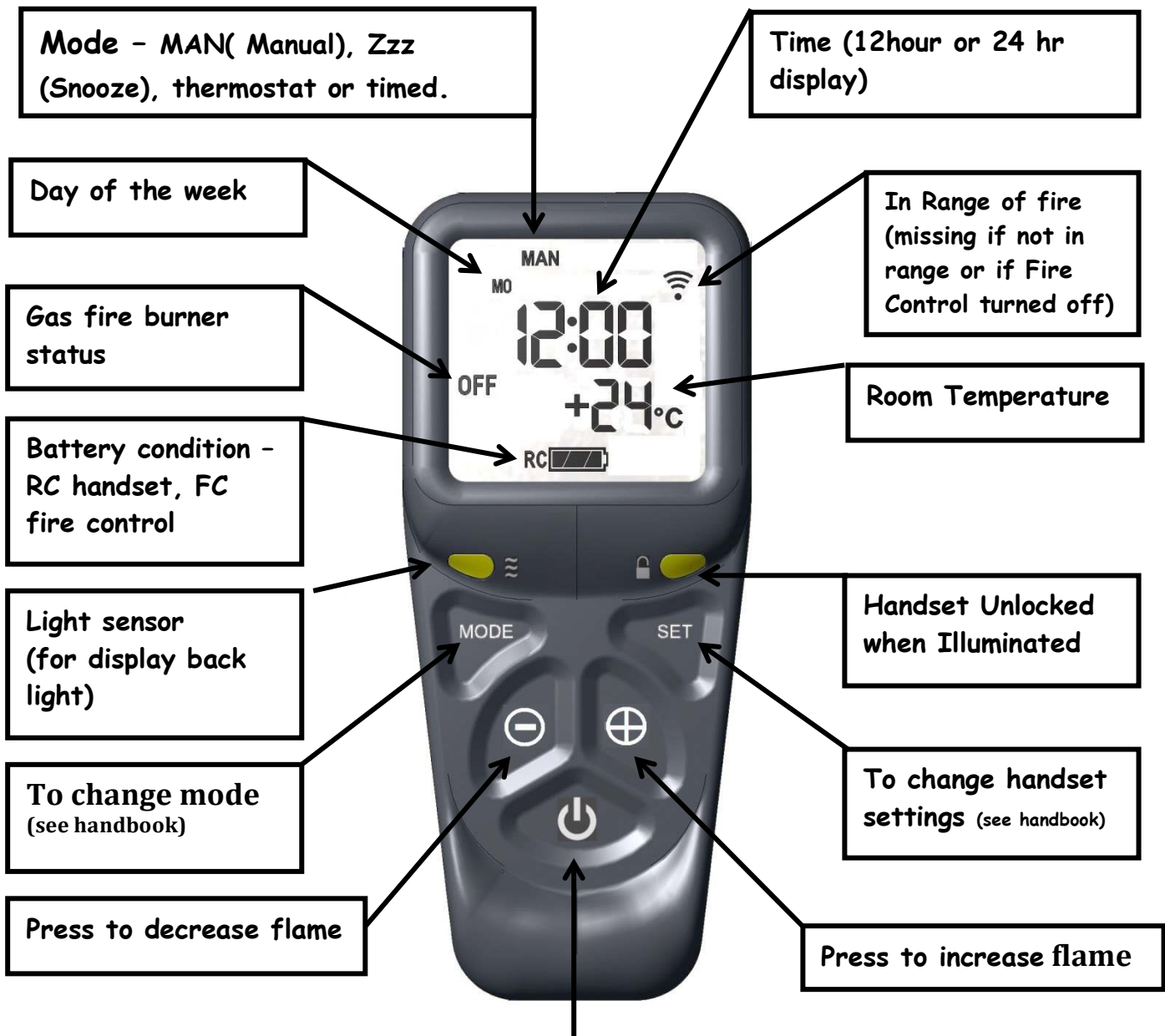

Power button - To start the fire, (after following the instructions of the previous page), with one hand grasp around the rear of both sides of the button area control. The green unlock light will illuminate. Keep the handset held to keep the control unlocked, to enable operation of the buttons. Then with the other hand touch and hold a finger on the power button for about 3 seconds. (A short beep and a flash of the unlock light will happen upon touching.) When the word "pilot" appears at the bottom left hand corner of the display, immediately release the power button. (A second flash of the unlock light and a longer beep will also sound at the time to release the power button). The Fire should be lit within a few seconds. (N.B. If power button is held for more than a few seconds after second flash/beep/word pilot appears, the command is ignored for safety reasons. Similarly if it is released too soon before the word pilot appears, the command is also ignored. With this system, the control has been designed to ensure that only intended ignition of the fire occurs.) To stop - with handset held to unlock it, press then release power button.

Operating instruction (Detailed)

Upon successful insertion of the batteries in the Handset the display will be as shown. The handset will be supplied paired to the fire and all that is required is to set the time of day and select if a 24h hour clock or 12 hour clock display is required and if temperature display is on Celsius or Fahrenheit.



Setting the time

Holding the handset as described previously to unlock the keypad, press and hold "SET" for a few seconds and the display will be as shown

Setting the display for 12 or 24 Hour display

As always when pressing the remote control buttons keep the control held to keep the green light on and therefore handset safety feature, unlocked. The H indicates that it is time to set the timer to either 24 hour display or 12 Hour (AM or PM) display. Press the + or - button on the handset to toggle between the two settings. When you are ready to confirm the setting you want press the "SET" button to progress to setting the day of the week.



Setting the day of the week

Press and release the + and - buttons until the correct day of the week is shown on the display.

(Mo = Monday, Tu= Tuesday, We=Wednesday, Th=Thursday, Fr=Friday, Sa= Saturday and Su=Sunday).

Press "SET" to accept the day of the week and to progress to setting the Hour of the day.

Note: Whilst doing this setup pressing "SET" advances to the next display and pressing "MODE" will return you to the previous display setting.



Setting the Hour

Press and release the + or - button to change the hour to the correct hour and press set to store and to move to setting the minute.

Repeat this for setting the minutes.

Setting the temperature display to Celsius or Fahrenheit.

Press and release the + or - button to toggle between C and F .

When the display shows the desired symbol, press and release the "SET" button to store.

As the important settings above have now been done. Press and hold (not releasing straight away) the "SET" button for a few seconds and this will exit the setup menu.(alternatively you can press and release the set button several more times until the time of day is displayed on the handset.

The control is now ready for use with the Fire Control.

Note: the legend at the bottom shows the battery condition of both the batteries in the hand set and in the fire control alternately. RC = Remote Control handset and FC = Fire control. The control is designed to get the most out of the batteries but when eventually the display shows they are spent(when the battery legend is a empty area, we recommend you change the batteries in the handset before they are flat, to avoid having to re-program the time of day in again. N.B. Pairing is not lost, even if the batteries are removed or flat. The pairing is not lost when the batteries are flat but replacing them quickly before they have gone flat will avoid having to set the time of day, day of the week etc again)



Paging the handset

If you have misplaced the handset (and it is in range of the fire), you can page it by pressing the + button only on the fire control for around 5 seconds. The handset will flash and make a noise to help you to locate it. Once you pick up the TESC it knows you hold it and so the sound stops. The flashing and sound will last for 60 seconds each time the handset is paged as described. If not found in 60 seconds, page again and so on. NOTE: PRESS "+" Button ONLY , NOT "+" and "-" Together as you will accidentally break the handset pairing and have to reset handset to factory state and pair again (see other parts of the booklet if this happens).

Advanced settings Menu

In the event that you may want to change the other preset settings of the control features. Do not do a long press and hold above but a normal short press and release will take you into the advanced settings area.

Advanced settings options are:-

- Back light -
 - A = Automatic (default setting). The back light comes on in the dark but not in the light.
 - 0 = Light never comes on.
 - 1 = Light comes on when ever handset is unlocked.
- Display contrast - 8 levels from 0 to 7 (default level 4) .
- P = pairing with other devices other than the fire control. The hand set can pair with other modules to :-
 - L= Operate an electric light - which is the dimmable in 9 steps
 - F= operate an electric fan -which can have 9 speed levels
 - A= operate an auxiliary contact to operate another device.

Other Modes than Manual mode

Depending upon the model of Fire your handset maybe enabled to have some automatic features, namely, Thermostat mode, timed thermostat mode and snooze mode. Snooze mode can be selected to work with in conjunction with either manual or thermostatic modes.

You can switch between modes at any time with the handset unlocked by pressing and releasing mode button to toggle between modes.

Note: If at any time the power button is pressed during operation, this will stop the fire and exit any automatic mode and return the handset to manual (MAN) operation mode.

Snooze mode in manual operation

Snooze mode is a time period you can set which will turn off the fire after a certain time period has elapsed.

The snooze time period can be set before or during manual operation of the fire. Hold the handset to unlock as described previously and press the mode button as many times as necessary until the word MAN and the Zzz symbols are flashing at the top of the display. Press and release the set button and this will put the control into Manual snooze mode.

The default time period for the snooze time period is 1:00 hour. Pressing the set button again will show you the snooze time period remaining. This can be adjusted by pressing the "+" or "-" buttons. The timer period that can be set is from 1 minute to 4:00 hours.

After adjusting the time, press set again to enter the time setting required (or if left for a few seconds this time is now stored and used).

Once this countdown timer has reached zero the fire will turn off (as if you had pressed off manually, it does not recycle).

Snooze mode in Thermostatic mode

The same thing as above can be done before or during a thermostatic mode operation (see below).

Thermostatic mode for closed fires

The handset has within it a thermostat sensor and this can be set so the fire will heat the room to match the temperature set in the handset.

There are 3 temperature types that can be set:-

-Day mode temperature that has a sun symbol on the display - the default temperature is 24 C

- Night temperature that has a half moon symbol on the display- the default temperature setting is 18 C

-frost protection that has a snowflake symbol on the display - the default temperature setting is 5 C

Hold handset and press and release the mode button several times as necessary until the display has a thermometer symbol flashing at the top of the display. Press the set button to enter this mode.

Press the set button again to see the temperature setting that is set and the mode (the default is 24 C) and on the left of the display is a sun symbol showing it's the day temperature.

If a different set temperature is required, while the display is showing this set temperature , press the + and - buttons to alter the setting. When finished either press set or leave and after a few seconds the new setting will be accepted and the display will return to the time of day screen.

On the anniversary of the set temperature of the clock, the set temperature will be compared to the actual temperature displayed on the handset(i.e. the room ambient temperature around the handset). If the room temperature is higher than the set temperature the fire will not light until the room has cooled to below the set temperature. The fire would then automatically turn itself on when the room is cooler than the set temperature and down and off if necessary when it is hotter than the set temperature.

(Note- when the set temperature is reached while the fire is in operation, the fire reduces the burner power level each minute until the burner is off. The pilot (if fitted) will remain on for a further 30 minutes and if the set temperature is still too high, the pilot will then also extinguish. When the set temperature is higher than the actual temperature, the fire will automatically light and go to the full burner rate to reheat the room back to the set temperature.

Note: If at any time the power button is operated during Thermostat mode, the control will cancel any thermostat operation and return the control to manual mode.

For ease of setting there are two other modes that can be selected as stated above. Night mode (moon symbol) and frost protection setting (a snow flake). These can be selected (and adjusted if necessary) by pressing set then mode while in thermostat mode. Pressing mode button toggles through from day to frost modes. The purpose of these settings is to help your fire to automatically protect you home against becoming too cold if there is a sudden change in the weather. The control must be left in the appropriate mode for this to function.

Note: As stated in an earlier section, snooze function can also be operated in conjunction with thermostat mode. The thermostat symbol and the Zzz symbol will be on together when in this mode.

Thermostat mode for open fires

This is the same as for closed fires except that :-

The fire will not ignite automatically and it will only regulate between minimum and maximum burner setting. The fire is lit manually by the remote control and then you enter thermostat mode as described above and set the temperature. When no longer requiring thermostat mode. Turn off the burner as described above and the handset returns to manual mode.

Timed thermostat mode(Closed fires Only)

This mode enables the various day, night and frost thermostat modes to be set on a program timer. The control will work as a thermostat switching between the day, night and frost temperature settings in line with the program set.

The set up of the timer will be shown by a demonstration.

To set up the timed thermostat to be at 24 C from 06:00 to 09:00 then drop to 18 C from 09:00 to 15:30 and then 24 C again from 15:30 until 23:30 and then to protect from frost a 5 C setting between 23:30 to 06:30 the next day from Monday to Friday this is what you would do:-

Hold handset to unlock - press set and hold until a beep and release. Press MODE button until the timer symbol is flashing on the top of the display - press set to enter the time mode - Mo is flashing so it is already set for Monday- press SET and release now press the + and - buttons to make the time of day read 06:00(note the steps are in 15 minutes steps) - press SET and release- press + and - to make the next symbol show a flashing sun symbol- press and release SET- as Mo is flashing press and release SET again enter the next time of 09:00- press and release SET- change the flashing sun symbol to a flashing moon symbol by pressing and releasing the + and - buttons then press and release SET again to store the moon setting (18 c)- continue this until you have entered each time and temperature change required for each day.

To put the fire into thermostat timer mode press and release the mod button until the thermostat and timer symbols are displayed on the display at the top. Press and release the "SET" button and the control will now run the timed program set up in the memory.

To adjust any time setting in the memory re enter the timer program setup mode (by pressing SET and then MODE as described above). Then press set to make the time flash. Now holding the + button advances the display to the next setting and so on throughout the program. Amend the appropriate setting and when finished do a long press of the SET button to exit the program mode.

To rest the whole timer program in the memory:-

Hold handset- press set- press mode until SETUP is flashing- press SET to enter SETUP- press SET about 8 times until CPO is flashing on the display- use the + and - buttons to change the display to CP1 - press SET - press SET again and the display will return to standby Manual mode and the timer setting have been completely removed for the timer memory.

Handset - without display



Buttons



Power button - for On/Off of burner



Increase burner power



Decrease burner power



Activity Light - flashes red when starting and stopping burner only.





Illuminates when key pad is unlocked

SET Button not used for operation

AUX Button used for operating an auxiliary device (sometimes not used depending upon you fire model)

Starting the fire

Pickup and keep hold of the handset as described above to unlock the keypad.

Press and hold the power button  continuously until the red light illuminates next to the  symbol (this takes typically 3 seconds). As the red light illuminates release immediately the power button. The red light will then flash as the burner is being lit. While the burner is lighting the red light will flash. When the burner has lit the

red light will stop completely. The burner will be at maximum burner rate when first lit.

You may now put the handset down.

Note: If the power button differently to the above i.e. pressed for too long or too short a time or the grip on the handset is not firm or released too soon, the Ignition will be interrupted and not complete. The reason for the remote control having this strict start sequence is for safety reason so that the starting operation of the fire will be most unlikely to be done other than intentionally by an adult. If not done correctly, wait a few seconds and try again

Burner regulation

When the burner is in operation, hold the handset as described above to unlock the keypad and then press and release the + and - buttons to regulate the flame of the burner. Pressing and releasing the button will move the burner one step at a time. Pressing the button continuously will move the burner rate to the maximum full when pressing + or minimum burner power if pressing -.

Stopping the burner

Pick up and hold the handset as described above to unlock the keypad.

Press and then release the power button once. The handset will beep and the burner will stop

Paging the handset

If you have misplaced the handset you can page it by pressing the + button only on the fire control for around 5 seconds. The handset will flash and make a noise to help you to locate it. Once you pick up the TESC it knows you hold it and so the sound stops. The flashing and sound will last for 60 seconds each time the handset is paged as described. If not found in 60 seconds, page again and so on. NOTE: PRESS "+" Button ONLY , NOT "+" and "-" Together as you will accidentally break the handset pairing and have to reset handset to factory state and pair again (see other parts of the booklet if this happens).

Switch panel

Red indication light

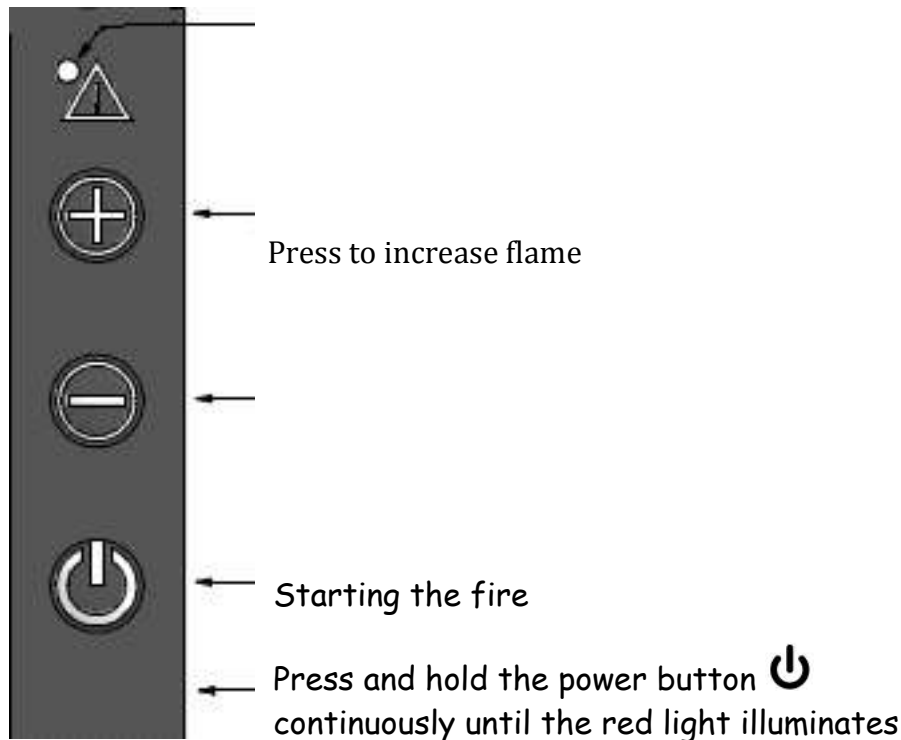

next to the  symbol (this takes typically 1 second). As the red light illuminates release immediately the power button. The red light will then flash as the burner is being lit. While the burner is lighting the red light will flash. When the burner has lit the red light will stop completely. The burner will be at maximum burner rate when first lit.

Note: If the power button is pressed for too long or too short a time this is taken as an accidental press and the fire will not ignite for extra safety reasons. It is to try an ensure that the starting operation of the fire will be most unlikely to be done other than intentionally by an adult. If not done correctly , wait a few seconds and try again.

If you wish to power down the fire so it will not start even if any of the power symbol buttons are pressed, slide the "power Isolating switch to the "0" position (perhaps a good idea to do in the event of leaving the fire not operated for long periods like the summer months or when going on long holidays).

Burner regulation

When the burner is in operation, press and release the + and - buttons to regulate the flame of the burner. Pressing and releasing the button will move the burner one step at a time. Pressing the button continuously will move the burner rate to the maximum full when pressing + or minimum burner power if pressing -.

Stopping the burner

Press and then release the power button once. The burner will stop and the red indicator light will illuminate momentarily to show the fire is turning off.

INSTRUCT THE USER

10.0

Instruct the user on the safe operation of the appliance.

Demonstrate how to operate the Remote Control System.

Explain the function of the ODS as described earlier.

Any cleaning procedures should only be undertaken with the appliance cold.

Show the Customer how to gain access to the Glass Door for cleaning on the Outside and how to gain access to the Inside for cleaning.

Advise the customer that the fire must **never** be used with the Door Open or if the Glass Panel is found to be cracked Chipped or damaged.

Hand all the Instructions to the user for safekeeping and future reference.

Advise the Customer that the Batteries in the Remote Control Hand Set and Receiver must be replaced When the appliance is serviced

Advise the customer that the **flue and fire should be serviced Annually** for continued safe operation

Certain wall coverings like blown vinyl should not be used on the wall above the fire

MAINTENANCE

11.0

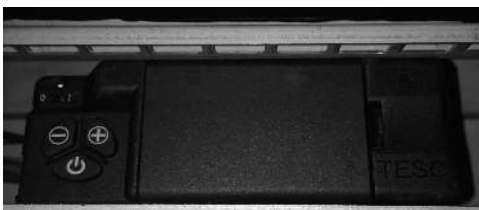

To change the batteries it is recommended this is performed during annual servicing

If required before the glass panel must be removed by removing the outer frame unscrewing the 4 screws

Remove the glass & remove the fuel pieces and stone chippings keeping them safe



Remove the 6 screws holding the fire tray cover the tesc will be seen as photograph top left ,remove the plastic cover to access the batteries ,replace like for like then replace cover and fuel following instructions .

11:1

Any cleaning should be carried out when the appliance is cold the fire will retain heat for some time after it has been switched off

11:2

If any fuel pieces is seen to be broken or damaged replacements must be obtained from the supplier

If soot is seen to be building up on the fuel pieces it is indicating that the fire requires servicing

11:3

Due to the nature of the convection air flowing over the fire, The walls of the room directly and around and above the fire may become discoloured slightly

CERTAIN WALL COVERINGS LIKE BLOWN VINYL SHOULD NOT BE USED ON THE WALL AROUND THE FIRE

11:4

Again ensure the fire and glass panel are cold before proceeding.

Like all glass windows the glass will become dirty and require cleaning.

The glass door can be cleaned on both the **outside** and **inside** with a damp cloth, allowed to dry then wiped with a Dry cloth to remove smears. To do this Remove the 2 screws at the top and bottom Left and top and bottom right Hand side and remove, the glass will pull forward at the bottom and pull out of the channel at the top, replace in reverse order

Important.

After cleaning it is important that the Glass Door is sealed closed with the fixing screws. If the Glass Door Panel is found to be Cracked, Chipped or Damaged the Fire Must Not Be used until it has been replaced

Important do not disturb the fuel pieces

For spares and service contact your local supplier or installer stating the model and serial number

Regular service and inspection should be undertaken to ensure continued safe operation, it is recommended that your fire and flue should be checked and serviced annually by a competent person for continued safe operation

PART NUMBER	DESCRIPTION
CONNELLY 01	REMOTE HANDSET WITH DISPLAY

12:0

GENERAL CHECKS PRIOR TO ANY SERVICING

A COMPETENT PERSON WITH A CURRENT GAS SAFE APPROVAL MUST SERVICE THE APPLIANCE EVERY YEAR

A GAS SOUNDNESS TEST BE CARRIED OUT PRIOR TO SERVICING

IT IS ALSO RECCOMENDED THAT THE OPERATION OF THE APPLIANCE CHECKED PRIOR TO ANY SERVICING, AFTER THESE CHECKS ENSURE THE APPLIANCE IS COLD BEFORE ANY SERVICING BEGINS

12:1

General servicing

It is recommended that the ods and mica fil is replaced during any servicing, please ensure they have been purchased before servicing begins

Lay a dustsheet in front of the fire

Remove 4 screws holding glass frame

Pull glass away at bottom corners and remove glass panel, inspect for damage and store in a safe place

Remove fuel pieces and inspect for damage or soot clean or replace as necessary

Remove stone chippings and store

Providing the mica fill replacement bag has been purchased if so vacuum the mica fill from the burner and ensure all burner ports are cleaned

Vacuum around the top tray where any debris or dust has been left by the stone chippings

The top burner cover can now be removed by unscrewing the 6 screws holding it in place

With the top burner cover removed the batteries in the tesc remote control unit can be changed, only use alkaline batteries of good quality see **11:0**

The 3 screws holding the burner in place can now be removed and then lift away the burner from the right and slide away

The gas supply can now be isolated and the 4 screws holding down the burner tray removed and the burner tray lifted out carefully ensuring the fibre panels are not damaged, at this point the injector can be examined and cleaned and replaced if necessary the gas valve can also be checked and replaced if necessary

With the burner removed the inspection cover on the rear of the fire can be unscrewed and any debris that have accumulated can be removed, refit the panel ensuring a good fit and it is sealed

Vacuum the inside of the firebox before replacing the fire tray

Replace burner and the screws holding it down

Replace top burner cover and fuel using the instructions

Replace the glass panel and screw up the glass fixing frame

Check any faults have been corrected and re-commission the fire conducting the usual safety checks specifically gas soundness checks and spillage

Checking the gas rate and pressure would ensure the appliance has not changed since installation

PART	PART NUMBER
HANDSET WITH DISPLAY	CONNELLY 01
HANDSET WITHOUT DISPLAY	CONNELLY02
ODS	CONNELLY03
INJECTOR 500	CONNELLY04
STONE CHIPPINGS	CONNELLY05
LOGSET (STATE MODEL)	CONNELLY06
GLASS PANEL AND SEAL (STATE MODEL)	CONNELLY07
TESC GAS VALVE	CONNELLY08

WARNING

This appliance is a heating appliance and as with all heating appliances a fireguard should be used for the protection of children, the elderly and infirm. Fireguards should conform to B.S. 8423 : 2002 (Fireguards for use with gas heating appliances).